



BEDROCK TRADITIONAL BURNER WITH GLOWFIRE™ LOGS

INSTALLATION AND OPERATION MANUAL



Nat. Gas Model

LDBT48L-EN
LDBT60L-EN
LDBT72L-EN

Propane Model

LDBT48L-EP
LDBT60L-EP
LDBT72L-EP

Log Model

LDBT-DW48
LDBT-DW60
LDBT-DW72

WARNING

WARNING: If the information in this manual is not followed exactly, a fire or explosion may result causing property damage, personal injury, or loss of life.

FOR YOUR SAFETY: Do not store or use gasoline or other flammable vapors and liquids in the vicinity of this or any other appliance.

WHAT TO DO IF YOU SMELL GAS

- Do not try to light any appliance.
 - Do not touch any electrical switch; do not use any phone in your building.
 - Immediately call your gas supplier from a neighbor's phone. Follow the gas supplier's instructions.
 - If you cannot reach your gas supplier, call the fire department.
- Installation and service must be performed by a qualified installer, service agency, or the gas supplier.

INSTALLER: Leave this manual with appliance. **CONSUMER:** Retain this manual for future reference.



FOR INDOOR OR OUTDOOR PATIO USE

Certified to the Canadian and American National Standards: CSA 2.26 and ANSI Z21.60 for decorative gas appliances for installation in solid-fuel burning fireplaces.

Grand Canyon Gas Logs

3515 East Atlanta Avenue, Phoenix, Arizona 85040 | 602-344-4217 | grandcanyongaslogs.com

⚠ WARNING

- Do not operate appliance before reading and understanding operating instructions. Failure to operate appliance according to operating instructions could cause fire or injury.
- **This appliance is hot when operated and can cause severe burns if contacted.**
- **Any changes or alterations to this appliance or its controls can be dangerous and is prohibited.**
- Risk of fire or asphyxiation, do not operate appliance with safety screen removed and never obstruct the front opening of the appliance.
- Risk of burns. The appliance should be turned off and cooled before servicing.
- Do not install damaged, incomplete or substitute components.
- Risk of cuts and abrasions. Wear protective gloves, protective footwear, and safety glasses during installation. Sheet metal edges may be sharp.
- Do not burn wood or other materials in this appliance.
- Provide adequate ventilation and combustion air. Provide adequate accessibility clearance for servicing and operating the appliance.
- **Children and adults should be alerted to hazards of high surface temperature and should stay away to avoid burns or clothing ignition.**
- **Young children should be carefully supervised when they are in the same room as the appliance. Toddlers, young children and others may be susceptible to accidental contact burns. A physical barrier is recommended if there are at-risk individuals in the house. To restrict access to an appliance or stove, install an adjustable safety gate to keep toddlers, young children and other at-risk individuals out of the room and away from hot surfaces.**
- **Clothing or other flammable material should not be placed on or near the appliance.**
- **Due to high temperatures, the appliance should be located out of traffic and away from furniture and draperies.**
- Furniture or other objects must be kept a minimum of 36 inches (.9144m) away from the front of the appliance.
- Ensure you have incorporated adequate safety measure to protect infants/toddlers from touching hot surfaces.
- Even after the appliance is off, it will remain hot for an extended period of time.
- Check with your local hearth specialty dealer for safety screens and hearth guards to protect children from hot surfaces. These screens and guards must be fastened to the floor.
- **Any safety screen, guard or barrier removed for servicing the appliance, must be replaced prior to operating the appliance.**
- A fireplace screen must be in place when the appliance is operating unless other provisions for combustion air are provided, the screen shall have openings for the introduction of combusted air.
- Thoroughly clean the chimney, flue and existing appliance before installing the new appliance into it. Do not burn solid fuels in any appliance that is equipped with this gas log set.
- The installation, including provisions for combustion, and ventilation air required minimum permanent vent opening must conform with the NATIONALS FUEL GAS CODE (ANSI Z223.1/NFPA 54) and applicable local building codes.
- Do not operate appliance in the presence of gasoline or other flammable liquids and vapors. Keep area clear of other combustible materials. The appliance and its shut off must be disconnected from the gas supply piping system before any pressure testing of the system is done.
- It is imperative that the control compartments, burners and circulating blower and its passageway in the appliance and venting system are kept clean. The appliance and its venting system should be inspected before use and at least annually by a qualified service person. More frequent cleaning may be required due to excessive lint from carpeting, bedding material, etc. The appliance area must be kept clear and free from combustible materials, gasoline, and other flammable vapors and liquids.
- If the appliance shuts off, do not re-light until you provide fresh air. If appliance keeps shutting off, have it serviced. Keep burner and control compartment clean.
- Under no circumstances should this appliance be modified.
- Do not allow wind or fans to blow directly into the appliance. Avoid any drafts that alter burner flame patterns.
- Do not use a blower insert, heat exchanger insert or other accessory not approved for use with this appliance.
- This appliance must not be connected to a chimney flue pipe serving a separate solid fuel burning appliance.

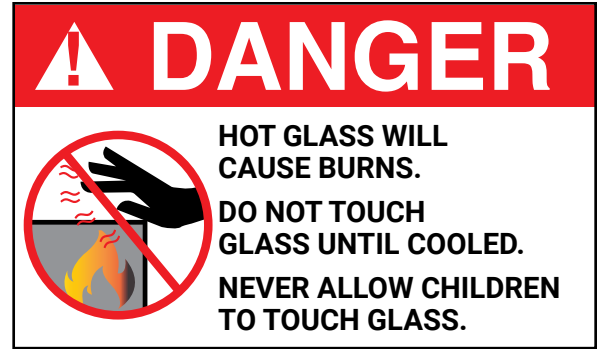

⚠ WARNING

- Do not use this appliance if any part has been under water. Immediately call a qualified service technician to inspect the appliance and to replace any part of the control system and any gas control which has been under water.
- Keep the packaging material out of reach of children and dispose of the material in a safe manner. As with all plastic bags, these are not toys and should be kept away from children and infants.
- Carbon monoxide poisoning may lead to death; early signs of carbon monoxide poisoning resemble the flu, with headache, dizziness and/or nausea. If you have these signs, the appliance may not be working properly. Get fresh air at once! Have appliance serviced. Some people; pregnant women, persons with heart or lung disease, anemia, those under the influence of alcohol, those at high altitudes are more affected by carbon monoxide than others. Failure to keep the primary air opening(s) of the burner(s) clean may result in sooting and property damage.
- As with any combustion appliance, we recommend having your appliance regularly inspected and serviced as well as having a Carbon Monoxide Detector installed in the same area to defend you and your family against Carbon Monoxide (not applicable for outdoor appliances).
- Ensure clearances to combustibles are maintained when building a mantel or shelves above the appliance. Elevated temperatures on the wall or in the air above the appliance can cause melting, discoloration or damage to decorations, a TV or other electronic components.
- **For appliances equipped with a safety barrier; if the barrier becomes damaged, the barrier shall be replaced with the manufacturer's barrier for this appliance.**
- **Installation and repair should be done by a qualified service person. It is imperative that control compartments, burners, and circulating air passageways of the appliance be kept clean.**
- For outdoor products only: this appliance must not be installed indoors or within any structure that prevents or inhibits the exhaust gases from dissipating in the outside atmosphere.
- Grab logs by the base with both hands. DO NOT use excessive force, slide off.
- Cracking and flaking of logs is normal with usage.

⚠ WARNING Failure to position the parts in accordance with these diagrams or failure to use only parts specifically approved with this appliance may result in property damage or personal injury.

⚠ WARNING This product can expose you to chemicals including lead and lead compounds, which are known to the State of California to cause cancer, and chemicals including carbon monoxide, which are known to the State of California to cause birth defects or other reproductive harm. For more information, go to www.P65Warnings.ca.gov.

⚠ WARNING Improper installation, adjustment, service or maintenance can cause property damage, personal injury, or loss of life. Refer to the Owner's Information manual provided with this appliance. Installation and service must be performed by a qualified installer, service agency or the gas supplier.

⚠ WARNING Vented Decorative Gas Appliance: Not a source of heat; Not for use with solid fuel. This appliance needs fresh air for safe operation and must be installed so there are provisions for adequate combustion and ventilation air.

⚠ WARNING This appliance is NOT for installation in manufactured or mobile homes.

⚠ WARNING Do not use the appliance if any part has been under water. Immediately call a qualified service technician to inspect the appliance and to replace any part of the control system and any gas control which has been under water.

⚠ WARNING**FIRE RISK HAZARD / DELAYED IGNITION**

High supply pressure will damage the valve / controls.

Disconnect the appliance main gas valve/control from the supply piping when pressure testing that system at pressures in excess of 1/2 psi (3.5 kPa).

Isolate the appliance with its shut off valve during any pressure testing of the supply piping at pressures equal to or less than 1/2 psi (3.5 kPa).

TABLE OF CONTENTS

| | |
|---|-------|
| Warning - Safety Information..... | 2-3 |
| General Instructions and Information | 5-7 |
| Parts List | 8-9 |
| Wiring Diagram, Pre-Installation | 10 |
| Pre-Installation Steps | 11-12 |
| Installation Steps | 13-14 |
| Log Placement | 15-20 |
| Outdoor Installation Requirements | 21-22 |
| Multifunction Remote Operating Instructions | 23-26 |
| Wi-Fi Multifunction Remote Operating Instructions | 27 |
| Intermittent Pilot Instructions | 28 |
| Maintenance | 29 |
| Troubleshooting | 30-31 |
| Warranty | 32 |

NOTE: Changes, other than editorial, are denoted by a vertical line in the margin.

| | | | |
|---|---|---|---|
| <p>LINE VOLTAGE</p>  <p>3515 E. Atlanta Ave. Phoenix, AZ 85040</p> | <p>DO NOT REMOVE THIS LABEL</p> <p>See installation & operating instructions for this model. Contact local building officials about restrictions and installation specifications in your area.</p> | <p>TESTED & LISTED BY:</p>  <p>ANSI-Z21 60-2017 CSA 2.26-2017 Decorative gas appliances for installation in solid-fuel burning fireplaces.</p> | |
| | <p>DATE OF MFG. <input type="text"/> SERIAL # <input type="text"/></p> | <p>C <input type="checkbox"/> US <input type="checkbox"/></p> <p>REPORT NO. (F23-120)</p> | |
| <p>MODEL: LDBT <input type="checkbox"/> L-EN</p> <p>HIGH BTU/HR (kW): <input type="checkbox"/> 48 <input type="checkbox"/> 62,000 (18.17kW)</p> <p>LOW BTU/HR (kW): <input type="checkbox"/> 45,000 (13.19kW)</p> | | <p><input type="checkbox"/> 60 <input type="checkbox"/> 95,000 (27.84kW)</p> <p><input type="checkbox"/> 60,000 (17.58kW)</p> | <p><input type="checkbox"/> 72 <input type="checkbox"/> 95,000 (27.84kW)</p> <p><input type="checkbox"/> 60,000 (17.58kW)</p> |
| <p>MODEL: LDBT <input type="checkbox"/> L-EP</p> <p>HIGH BTU/HR (kW): <input type="checkbox"/> 48 <input type="checkbox"/> 62,000 (18.17kW)</p> <p>LOW BTU/HR (kW): <input type="checkbox"/> 30,000 (8.79kW)</p> | | <p><input type="checkbox"/> 60 <input type="checkbox"/> 75,000 (21.98kW)</p> <p><input type="checkbox"/> 40,000 (11.72kW)</p> | <p><input type="checkbox"/> 72 <input type="checkbox"/> 75,000 (21.98kW)</p> <p><input type="checkbox"/> 40,000 (11.72kW)</p> |
| <p>NG Models</p> <p>Altitude Input Reduced Input P4 Manifold Pressure: 3.5" w.c. (NG) Minimum Supply Pressure: 5" w.c. (NG) Maximum Supply Pressure: 7" w.c. (NG) Pression au Collecteur: 87wPA d'une colonne d'eau (GN) Pression d'Alimentation Min.: 1.25wPA d'une colonne d'eau (GN) Pression d'Alimentation Max.: 3.5wPA ** d'une colonne d'eau (GN) ** Maximum inlet pressure not to exceed 13". Minimum clearance to combustible materials: Top, sides & back: per standoff spacers for framing and finishing materials. For non-combustible framing and finishing materials, see installation manual.</p> | <p>MANIFOLD PRESSURE: ELECTRICAL RATING: 120V/60HZ GAS TYPE: NATURAL GAS / LIQUID PROPANE</p> | <p>LP Models</p> <p>Élévation Alimentation / Alimentation Réduite P4 Manifold Pressure: 10" w.c. (LP) Minimum Supply Pressure: 11" w.c. (LP) Max. Supply Pressure: 14" w.c. (LP) Pression au Collecteur: 2.40wPA d'une colonne d'eau (LP) Pression d'Alimentation Min.: 2.74wPA d'une colonne d'eau (LP) Pression d'Alimentation Max.: 3.5wPA * d'une colonne d'eau (LP) ** Pression d'alimentation maximale ne devait pas dépasser 3.5wPA. Dégagements minimaux des matériaux combustibles: Dessus, côtés et arrière: selon les espacements de dégagements pour les matériaux d'ossature selon le manuel du propriétaire pour les matériaux de finition</p> | |
| <p>VENTED DECORATIVE GAS APPLIANCE: NOT A SOURCE OF HEAT; NOT FOR USE WITH SOLID FUEL. APPAREIL DÉCORATIF À GAZ VENTILÉ: PAS UNE SOURCE DE CHALEUR; NE PAS UTILISER AVEC DU COMBUSTIBLE SOLIDE.</p> | | | |
| <p>THIS APPLIANCE NEEDS FRESH AIR FOR SAFE OPERATION AND MUST BE INSTALLED SO THERE ARE PROVISIONS FOR ADEQUATE COMBUSTION AND VENTILATION AIR. CET APPAREIL A BESOIN D'AIR FRAIS POUR UN FONCTIONNEMENT SÉCURISÉ ET DOIT ÊTRE INSTALLÉ POUR IL Y A DES DISPOSITIONS POUR UN AIR DE COMBUSTION ET DE VENTILATION ADÉQUAT.</p> | | | |
| <p>This appliance is not for installation in manufactured homes. Cet appareil n'est pas destiné à être installé dans des maisons préfabriquées.</p> | | | |
| <p>The installation, including provisions for combustion, ventilation air, and required minimum permanent vent opening, must conform with National Fuel Gas Code (ANSI Z223.1/NFPA 54) and applicable local building codes. L'installation, y compris les dispositions pour la combustion, l'air de ventilation et l'ouverture de ventilation permanente minimale requise, doit être conforme au National Fuel Gas Code (ANSI Z223.1 / NFPA 54) et aux codes du bâtiment locaux applicables.</p> | | | |
| <p>⚠ WARNING: This gas appliance must not be connected to a chimney fuel servicing a solid fuel burning appliance. ⚠ AVERTISSEMENT: Cet appareil à gaz ne doit pas être raccordé à un combustible de cheminée desservant un appareil à combustible solide.</p> | | | |
| <p>⚠ WARNING: THIS FIREPLACE IS NOT INTENDED FOR BURNING SOLID FUELS. ⚠ AVERTISSEMENT: CE FOYER N'EST PAS DESTINÉ À BRÛLER DES COMBUSTIBLES SOLIDES.</p> | | | |

Damper Stop Installation

The damper must be permanently locked in position to prevent full closure and to provide a minimum flue opening. Various methods for locking the damper may be used but may be restricted from region to region and it is important to know the specifics that apply to your area. For your convenience a damper stop is provided with the appliance and may be used where not prohibited by state or local codes.

Use the 3" adjustable bolt to adjust the damper to the correct opening, based on the enclosed chart.

Should the damper stop not fit, or provide the required permanent opening from the Minimum Damper Opening table, have the damper cut to provide a minimum permanent opening or install an alternate stop.

Creosote, ashes, and loose paint must be cleaned from the chimney flue and firebox by a qualified chimney cleaner, before installing in a solid fuel burning appliance. Any outside air ducts and/or ash dumps in the fireplace shall be permanently closed at time of appliance installation.

If the damper stop (supplied) is not applicable the damper may be fixed open by the following method:

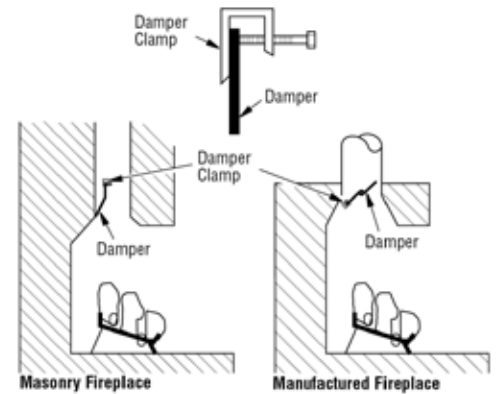

- Drill a hole in either end of the damper.
- Using a bolt of sufficient length and adjustment, with 2 nuts, secure to damper through the hole.
- Adjust to correct opening.

Appliance must be installed only in a solid-fuel burning fireplace with a working flue and constructed of non-combustible material.

Venting Requirements

| Free opening area of chimney damper for venting combustion products (factory-built fireplaces) | | | | | | | | | | | | |
|--|--------------------------------|------|-------|------|------|------|------|------|------|------|------|---------------|
| Chimney Height (ft) | Appliance Input Rate (kBTU/hr) | | | | | | | | | | | Maximum Input |
| | 20 | 30 | 40 | 50 | 60 | 70 | 80 | 90 | 100 | 110 | 120 | |
| 10 | 11.3 | 16.6 | 22.11 | 28.3 | 35.3 | 44.2 | - | - | - | - | - | 77.6 |
| 15 | 8.6 | 12.6 | 17.3 | 21.2 | 26.4 | 32.2 | 38.5 | 45.4 | - | - | - | 98.2 |
| 20 | 7.5 | 10.8 | 14.5 | 18.1 | 22.1 | 26.4 | 31.2 | 37.4 | 43 | - | - | 114.2 |
| 25 | 6.6 | 9.6 | 12.6 | 15.9 | 18.1 | 22.9 | 27.3 | 31.2 | 36.3 | 43 | 50.3 | 121 |
| 30 | 6.2 | 9.1 | 11.3 | 14.5 | 17.3 | 20.4 | 24.6 | 28.3 | 33.2 | 37.4 | 44.2 | 130.1 |
| 35 | 5.7 | 8 | 10.8 | 13.2 | 15.9 | 18.9 | 22.1 | 25.5 | 30.2 | 34.2 | 39.6 | 141.2 |
| 40 | 5.6 | 7.5 | 10.2 | 12.6 | 15.2 | 18.1 | 20.4 | 23.8 | 27.3 | 31.2 | 35.3 | 158.5 |

Height is from hearth to top of chimney and the minimum height is 10 feet

Chart shows some minimum opening (in2) for the given height and input rate.

Column marked "Maximum input" corresponds to the maximum allowable input rate (kBTU/hr) for the given height

| Free opening area of chimney damper for venting combustion products (masonry-built fireplaces) | | | | | | | | | | | | |
|--|--------------------------------|------|------|------|------|------|------|------|------|------|------|--|
| Chimney Height (ft) | Appliance Input Rate (kBTU/hr) | | | | | | | | | | | |
| | 20 | 30 | 40 | 50 | 60 | 70 | 80 | 90 | 100 | 110 | 120 | |
| 6 | 17.6 | 25.7 | 33.8 | 41.7 | 49.2 | 56.6 | 64 | 71.4 | 78.8 | 86.2 | 93.5 | |
| 8 | 16.5 | 23.7 | 31.2 | 38.7 | 45.5 | 52.4 | 59.7 | 66.9 | 74.1 | 81.3 | 88.6 | |
| 10 | 15.1 | 21.7 | 28.7 | 35.2 | 41.7 | 48.2 | 54.3 | 60.2 | 66.1 | 72 | 77.9 | |
| 15 | 14.1 | 19.9 | 26.1 | 32 | 37.7 | 43.2 | 48.8 | 54.1 | 59.4 | 64.6 | 69.9 | |
| 20 | 12.9 | 18.5 | 23.7 | 28.8 | 34.3 | 39.8 | 44.4 | 49.1 | 53.8 | 58.4 | 63 | |
| 30 | 12.2 | 16.9 | 21.6 | 26.5 | 31.2 | 35.9 | 40.3 | 44.5 | 48.6 | 52.7 | 56.6 | |

Height is from hearth to top of chimney and the minimum height is 6 feet

Chart shows some minimum opening (in2) for the given height and input rate

| Min. Fire Box Size | | | | |
|---------------------------|-------|------|-------|--------|
| NG/LP | Front | Rear | Depth | Height |
| LDB48L | 48 | 48 | 15 | 20 |
| LDB60L | 60 | 60 | 15 | 20 |
| LDB72L | 72 | 72 | 15 | 20 |

BURNER SPECIFICATIONS

NATURAL GAS MODELS

| | Rated | Rated | Rated Manifold | Rated Inlet | Rated Inlet |
|------------|--------------|--------------|-----------------------|--------------------|--------------------|
| NG Models | High | Low | Pressure | min | max |
| LDBT48L-EN | 62000 | 45000 | 3.5 | 5 | 10.5 |
| LDBT60L-EN | 95000 | 60000 | 3.5 | 5 | 10.5 |
| LDBT72L-EN | 95000 | 60000 | 3.5 | 5 | 10.5 |

LIQUID PROPANE MODELS

| | Rated | Rated | Rated Manifold | Rated Inlet | Rated Inlet |
|------------|--------------|--------------|-----------------------|--------------------|--------------------|
| NG Models | High | Low | Pressure | min | max |
| LDBT48L-EP | 62000 | 30000 | 10 | 11 | 14 |
| LDBT60L-EP | 75000 | 40000 | 10 | 11 | 14 |
| LDBT72L-EP | 75000 | 40000 | 10 | 11 | 14 |

LOG IDENTIFICATION

| | |
|-----------|--|
| LDBT-DW48 | Bedrock Traditional 48" Western Driftwood Logs |
| LDBT-DW60 | Bedrock Traditional 60" Western Driftwood Logs |
| LDBT-DW72 | Bedrock Traditional 72" Western Driftwood Logs |

PARTS LIST

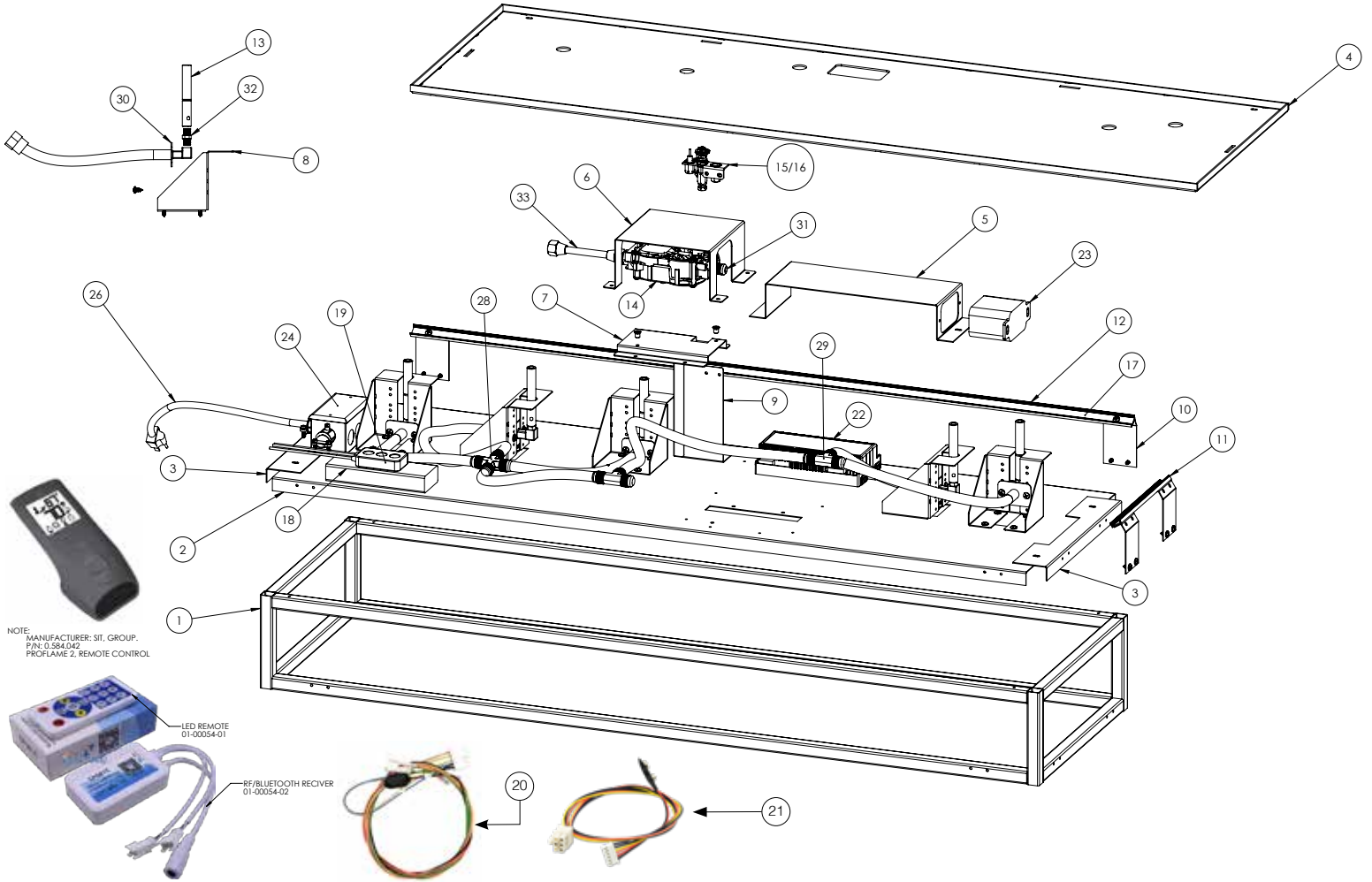

| # | Part # | Description | # | Part # | Description |
|----|-------------|----------------------------------|----|-------------|--|
| 1 | 02-00755-01 | 48" Frame for Drop-in Burner | | 0.885.006 | PF Modulating Valve (NG) 1.6-3.5 in. of W.C. |
| | 02-00755-02 | 60" Frame for Drop-in Burner | 14 | 0.907.015 | CK Step-M LPG 11-2.9 in. of W.C. (Propane Models Only) |
| | 02-00755-03 | 72" Frame for Drop-in Burner | 15 | 0.199.060 | Proflame II Pilot Assembly (NG) |
| 2 | 02-00737-01 | 48" Base Plate Component Housing | 16 | 0.977.167 | LPG Pilot Orifice (Propane models only) |
| | 02-00737-02 | 60" Base Plate Component Housing | 17 | 01-00049-08 | 48" LED LIGHTS |
| | 02-00737-03 | 72" Base Plate Component Housing | | 01-00049-09 | 60" LED LIGHTS |
| 3 | 02-00738-01 | Left Side Clamp | | 01-00049-10 | 72" LED LIGHTS |
| | 02-00738-02 | Right Side Clamp | 18 | 12v5a | LED Power Supply |
| 4 | 02-00742-01 | 48" Perforated Media Deck | 19 | SP601E | Wi-Fi / RF Controller |
| | 02-00742-02 | 60" Perforated Media Deck | 20 | 0.584.920 | Proflame II Wire Harness, 5x Terminal |
| | 02-00742-03 | 72" Perforated Media Deck | 21 | 0.584.922 | Proflame II Wire Harness, 8x Terminal |
| 5 | 02-00165 | Heat Shield, IFC Board | 22 | 0.584.306 | Proflame II IFC Board |
| 6 | 02-00748 | Heat Shield, Valve | 23 | 05.584.103 | Proflame II Battery Holder |
| 7 | 02-00730 | Valve Mounting Bracket | 24 | 01-00045 | Electrical Box Assembly |
| 8 | 02-00747 | Log Support Bracket | 25 | 0.584.042 | Proflame II Tx/TMFL-Black (SIT remote) |
| 9 | 02-00739 | Pilot Mounting Bracket | 26 | A01630 | 6 ft. Power Cord |
| 10 | 02-00164 | Angled LED Mounting Bracket | 27 | LED-RMT | LED Remote |
| 11 | 02-00123-11 | LED Lighting Track, Common Side | 28 | C-1-8 | 1/2" Cross, Flared |
| 12 | 02-00123-12 | 48" LED Lighting Track | 29 | 48-86 | 1/2" Tee, Flared |
| | 02-00123-13 | 60" LED Lighting Track | 30 | 2000MB-2 | Bulkhead Orifice Holder Brazed connector |
| | 02-00123-14 | 72" LED Lighting Track | 31 | U1-8C-S | 1/2" MIP to Flare |
| 13 | 02-00751-01 | Air Mixer Log Support for NG | 32 | 306-2-GC70 | Drilled & Stamped Orifice |
| | 02-00751-02 | Air Mixer Log Support for LPG | 33 | US-4-8 | 1/2" flare connector, 4 in. hardline |



| # | Part # | Description | # | Part # | Description |
|---|-----------|---------------------------------------|---|-----------|---------------------------------------|
| 1 | LDBTWD-48 | 48" Frame for Drop-in Burner | | 05-00183 | LOG #09 Static Log |
| 2 | LDBTWD-60 | 60" Frame for Drop-in Burner | | 05-00184 | LOG #10 Static Log |
| 3 | LDBTWD-72 | 72" Frame for Drop-in Burner | | 05-00185 | LOG #11 Static Log |
| 1 | LDBTWD-48 | 48" Bedrock Western Driftwood Log Set | | 05-00186 | LOG #12 Static Log |
| | 05-00175 | LOG #1 Burner Log | | 05-00187 | LOG #13 Static Log |
| | 05-00176 | LOG #2 Burner Log | 3 | LDBTWD-72 | 72" Bedrock Western Driftwood Log Set |
| | 05-00177 | LOG #3 Burner Log | | 05-00176 | LOG #1 Burner Log |
| | 05-00178 | LOG #4 Burner Log | | 05-00177 | LOG #2 Burner Log |
| | 05-00179 | LOG #5 Burner Log | | 05-00178 | LOG #3 Burner Log |
| | 05-00182 | LOG #8 Static Log | | 05-00179 | LOG #4 Burner Log |
| | 05-00183 | LOG #9 Static Log | | 05-00180 | LOG #5 Burner Log |
| | 05-00188 | LOG #14 Static Log | | 05-00181 | LOG #7 Burner Log |
| 2 | LDBTWD-60 | 60" Bedrock Western Driftwood Log Set | | 05-00182 | LOG #08 Static Log |
| | 05-00175 | LOG #1 Burner Log | | 05-00183 | LOG #09 Static Log |
| | 05-00176 | LOG #2 Burner Log | | 05-00184 | LOG #10 Static Log |
| | 05-00177 | LOG #3 Burner Log | | 05-00185 | LOG #11 Static Log |
| | 05-00178 | LOG #4 Burner Log | | 05-00186 | LOG #12 Static Log |
| | 05-00179 | LOG #5 Burner Log | | 05-00187 | LOG #13 Static Log |
| | 05-00180 | LOG #6 Burner Log | | 05-00188 | LOG #14 Static Log |
| | 05-00181 | LOG #7 Burner Log | | 05-00189 | LOG #15 Static Log |
| | 05-00182 | LOG #08 Static Log | | | |

System Configuration:

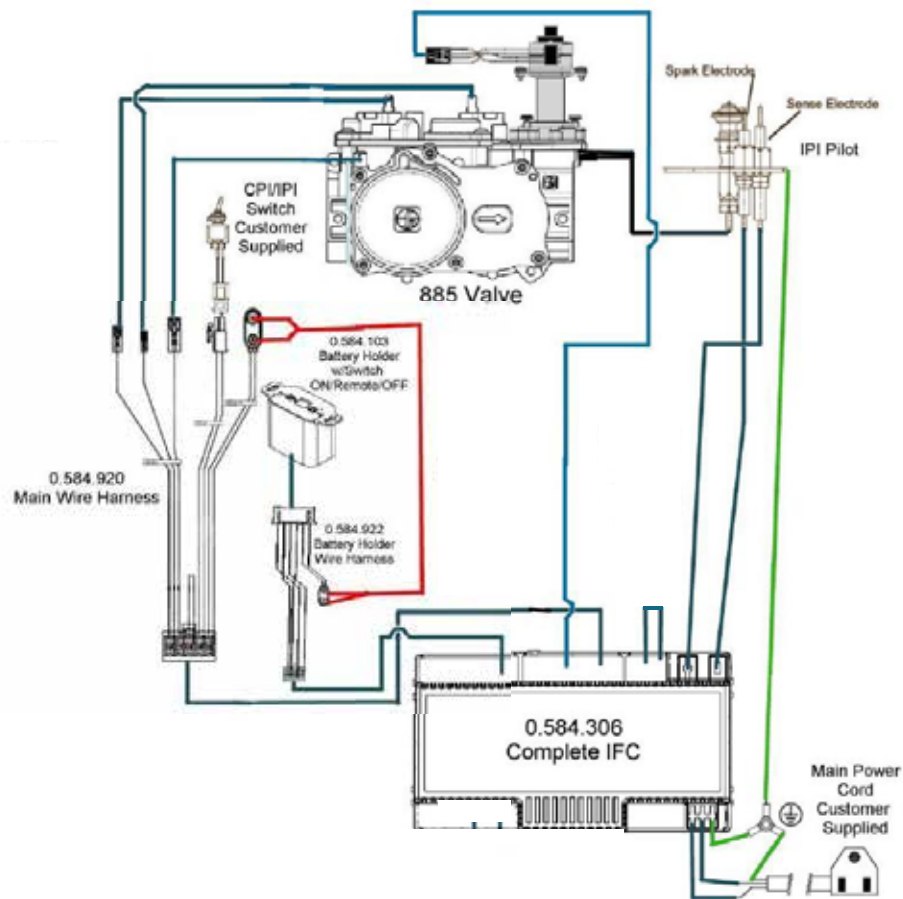

PRE-INSTALLATION

Before you begin

Thank you for purchasing Grand Canyon Gas Log's **Bedrock Traditional Burner with Glowfire™ Logs**. This product has been designed to provide you with safe, trouble-free operation.

Please read this manual thoroughly before beginning the installation. It has information which is important for safe installation and operation.

Please inspect your shipment for completeness and any damage. Contact your retailer if any damage is found. Do not install your appliance with any damage or substituted parts.

The installation of your **Bedrock Traditional Burner** will follow the steps listed:

- Pre-Installation planning - ensure the opening of the fireplace meets the specification.
- Electric installation (Right side - 6' cord). Reference page 12 for connection to gas supply information.
- Gas installation (Preferred left side)
- Installing the burner
- Media and log placement

Before you begin the installation you should have the following tools and supplies:

- Pipe wrenches
- Safety glasses and gloves
- Approved pipe joint sealant
- Manometer
- Leak detection fluid (non-corrosive) or electronic gas detector
- Appropriate gas supply line parts

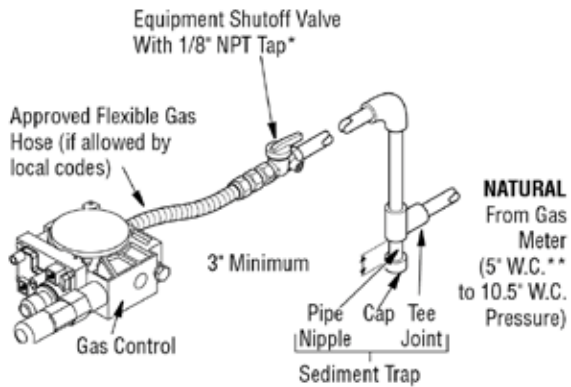

* Purchase the optional equipment shutoff valve from your dealer.
 **Minimum inlet pressure for purpose of input adjustment.

Figure B - Gas Connection

Install in piping system between fuel supply and appliance. Locate sediment trap where trapped matter is not likely to freeze. A sediment trap traps moisture and contaminants. This keeps them from going into appliance controls. If sediment trap is not installed or is installed wrong, appliance may not run properly.

CAUTION: Avoid damage to gas control. Hold gas control with wrench when connecting it to gas piping and/or fittings.

CHECKING GAS CONNECTIONS

WARNING: Test all gas piping and connections, internal and external to unit, for leaks after installing or servicing. Correct all leaks at once.

WARNING: Never use an open flame to check for a leak. Apply a noncorrosive leak detection fluid to all joints. Bubbles forming show a leak. Correct all leaks at once.

PRESSURE TESTING GAS SUPPLY PIPING SYSTEM

The appliance and its appliance main gas valve must be disconnected from the gas supply piping system during any pressure testing of that system at test pressures **in excess of** 1/2 psi (3.5 kPa). The appliance must be isolated from the gas supply piping system by closing its equipment shutoff valve during any pressure testing of the gas supply piping system at test pressures **equal to or less than** 1/2 psi (3.5 kPa).

Test Pressures In Excess Of 1/2 PSIG (3.5 kPa)

1. Disconnect appliance with its appliance main gas valve (control valve) and equipment shutoff valve from gas supply piping system. Pressures in excess of 1/2 psig will damage appliance regulator.
2. Cap off open end of gas pipe where equipment shutoff valve was connected.
3. Pressurize supply piping system by opening main gas valve located on or near gas meter for natural gas or using compressed air.

4. Check all joints of gas supply piping system. Apply noncorrosive leak detection fluid to all joints. Bubbles forming show a leak.
5. Correct all leaks at once.
6. Reconnect appliance and equipment shutoff valve to gas supply. Check reconnected fittings for leaks.

Test Pressures Equal To or Less Than 1/2 PSIG (3.5 kPa)

1. Close equipment shutoff valve (see Figure C).
2. Pressurize supply piping system by opening main gas valve located on or near gas meter for natural gas or using compressed air.
3. Check all joints from gas meter to equipment shutoff valve for natural gas. Apply noncorrosive leak detection fluid to all joints. Bubbles forming show a leak.
4. Correct all leaks at once.

PRESSURE TESTING APPLIANCE GAS CONNECTIONS

1. Open equipment shutoff valve.
2. Open main gas valve located on or near gas meter for natural gas.
3. Make sure control knob of appliance is in the OFF position.
4. Check all joints from gas meter to equipment shutoff valve for natural gas. Apply noncorrosive leak detection fluid to all joints. Bubbles forming show a leak.
5. Correct all leaks at once.
6. Light appliance. Check all other internal joints for leaks.

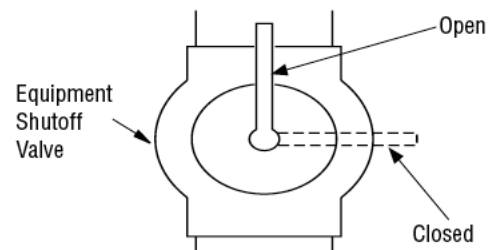

Equipment Shutoff Valve

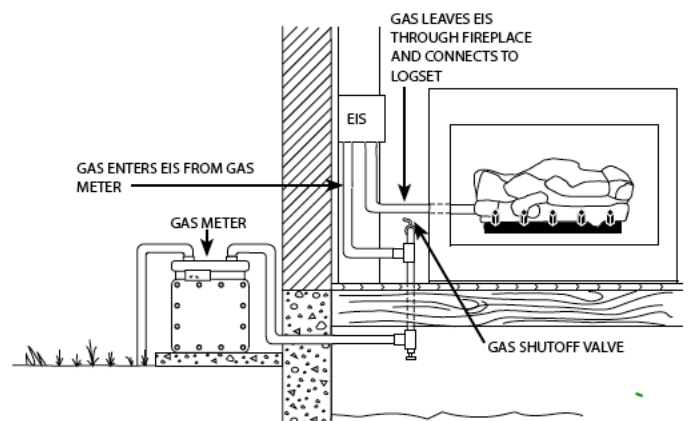

Checking Gas Joints (Natural Gas Only)

For Massachusetts Residents Only: Installation of this gas log set as a vented indoor appliance in the Commonwealth of Massachusetts requires the damper be permanently removed or welded in the fully open position.

You must install the damper clamp accessory. This will ensure vented operation. The damper clamp will keep damper open.

For minimum permanent flue opening you must provide. Attach damper clamp so the minimum permanent flue opening will be maintained at all times.

CONNECTING TO GAS SUPPLY

⚠ WARNING: This appliance requires a 1/2" NPT (National Pipe Thread) inlet connection to the pressure regulator.

⚠ WARNING: A qualified service person must connect appliance to gas supply. Follow all local codes.

⚠ WARNING: *Never connect this appliance to private (non-utility) gas wells. This gas is commonly known as wellhead gas and does not have odorants and may have impurities, and variations in BTU content. The use of well-head gas will void the manufacturer's warranty to this appliance.*

When an appliance is for connection to a fixed piping system, the installation must conform with local codes, or in the absence of local codes with the National Fuel Gas Code, ANSI Z223.1 • NFPA 54; National Fuel Gas Code.

⚠ CAUTION: Use only new, black iron or steel pipe. Internally-tinned copper tubing may be used in certain areas. Check your local codes. Use pipe of 1/2" diameter or greater to allow proper gas volume to appliance. If pipe is too small, undue loss of volume will occur.

Installation must include an equipment shutoff valve, union and plugged 1/8" NPT tap. Locate NPT tap within reach for test gauge hook up. NPT tap must be upstream from appliance.

IMPORTANT: Install equipment shutoff valve in an accessible location. The equipment shutoff valve is for turning on or shutting off the gas to the appliance.

Check your building codes for any special requirements for locating equipment shutoff valve to appliances.

Apply pipe joint sealant lightly to male NPT threads. This will prevent excess sealant from going into pipe. Excess sealant in pipe could result in clogged appliance valves.

1



Figure 1

STEP 1

Place Bedrock burner in your fireplace centering the base front to back and side to side. Centering the base allows the deck to easily sit on the top of the base. (Figure 1) Make sure gas has been ran & access to electrical is provided.

2



Figure 2

Make sure the fireplace meets minimum dimensions to be able to install Bedrock. (Figure 2)

3

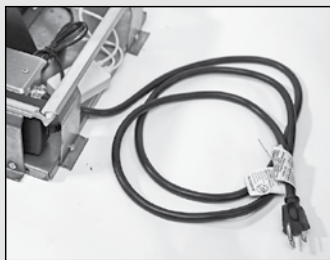

(A) - Figure 2.1

(B) - Figure 2.2

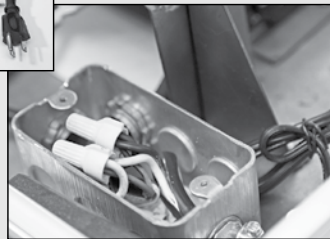

WIRING

(A) For use with the provided 6' power cord, electrical connection is on the right-hand side of the burner. Feed the power plug through the fireplace wall plugging into a 110v receptacle. (Figure 2.1)

(B) For hard wire installations: Electricians will remove the top of the electrical box, disconnect the pigtail wire nuts, feed line voltage electrical wire through the fireplace wall, replace pigtail connections with line voltage and tighten wire nuts, replace electrical box cover. (Figure 2.2) follow all local & national codes and safety laws.

4

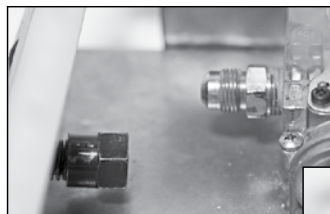

Figure 3.1

Figure 3.2



Attach gas connector to the gas supply line and connect to burner assembly gas valve. Use soapy water to check connections for leaks. "Longer gas connector maybe needed for unique installations" (not provided). (Figure 3.1 & 3.2)

5

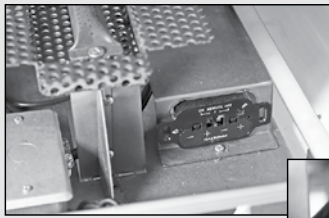

Figure 4.1



Figure 4.2

Place batteries in the battery holder and both remotes. Remotes are synced at factory prior to shipping. To re-sync the ProFlame II remote review the remote section of the manual. Pages 22-25.

6

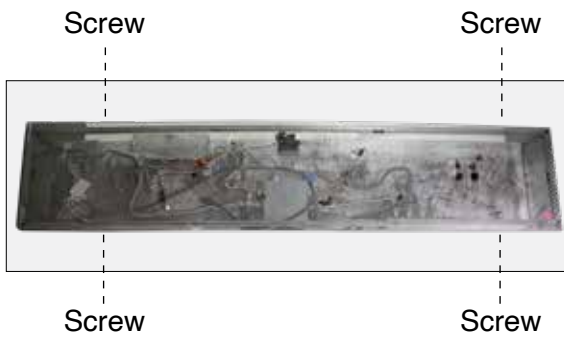

Place decking and secure screws to the base. Larger units may require two people to install.

7



Log placement first, than place, reflective glass media or lava rocks. Follow the log placement guide, lighting, and transmitter instructions to properly ignite your burner.

8

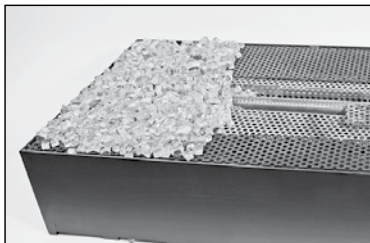
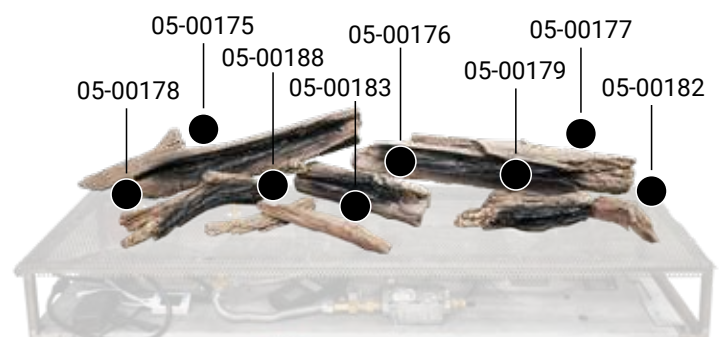
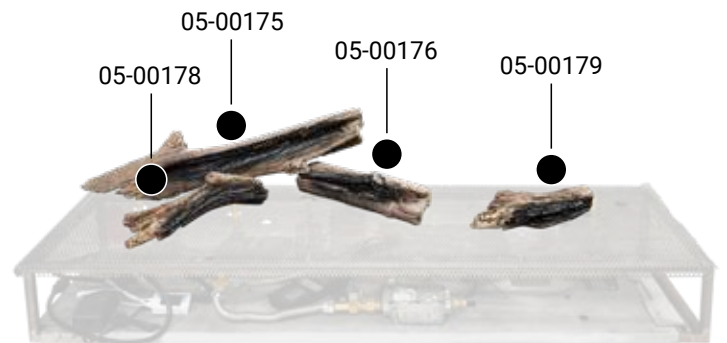
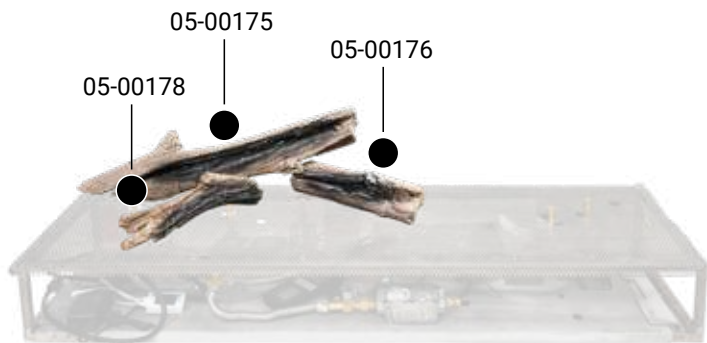
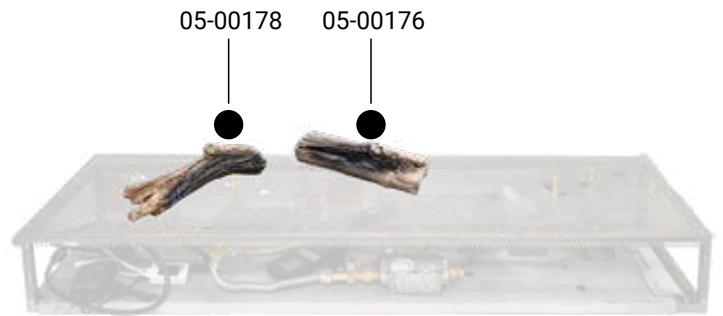
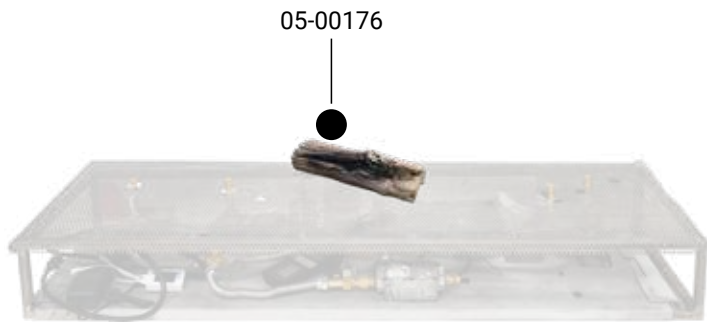

Figure 6.1

Pour the 1/2" reflective glass media over the top of the burner tube and the perforated metal (Fig.6.1). Note, for proper ignition there should be no more than one layer of glass over the top on the burner tube. Follow the chart below and make sure the proper amount of glass media is used. DO NOT cover the pilot shield with media, keep this area clear of all debris.

| Burner Size | LBS Glass Media Used |
|-------------|----------------------|
| 48" | 20 lbs. |
| 60" | 25 lbs. |
| 72" | 30 lbs. |

48" BURNER AND GLOWFIRE™ WESTERN DRIFTWOOD LOG PLACEMENT GUIDE





60" BURNER AND GLOWFIRE™ WESTERN DRIFTWOOD LOG PLACEMENT GUIDE

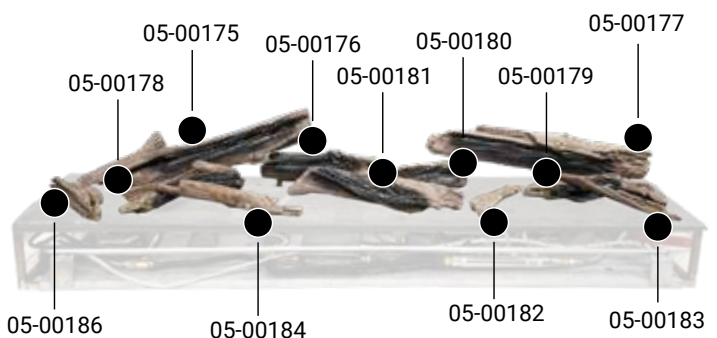
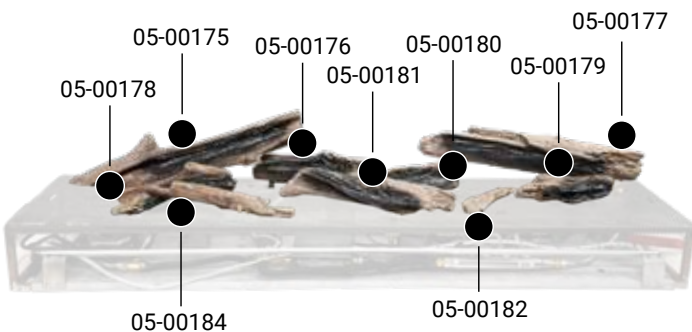
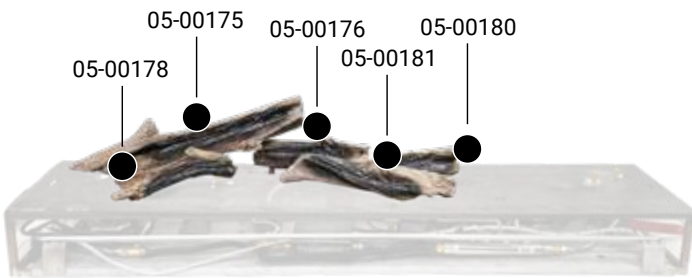
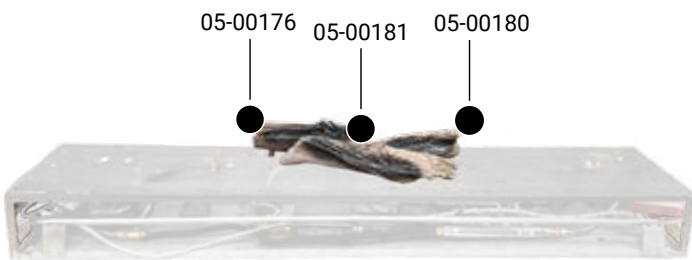
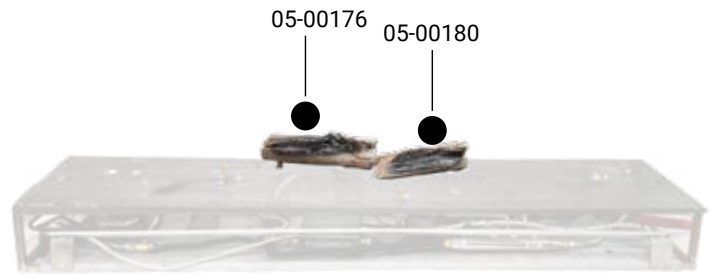
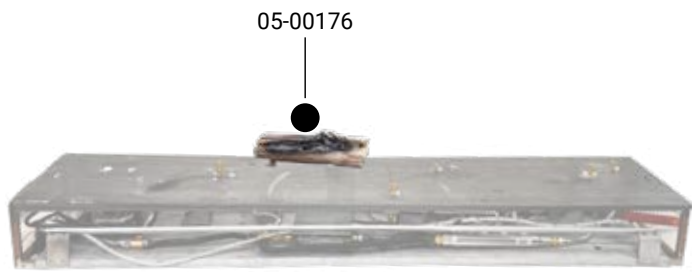



72" BURNER AND GLOWFIRE™ WESTERN DRIFTWOOD LOG PLACEMENT GUIDE

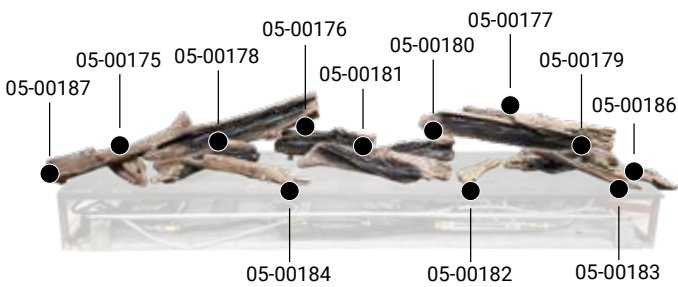
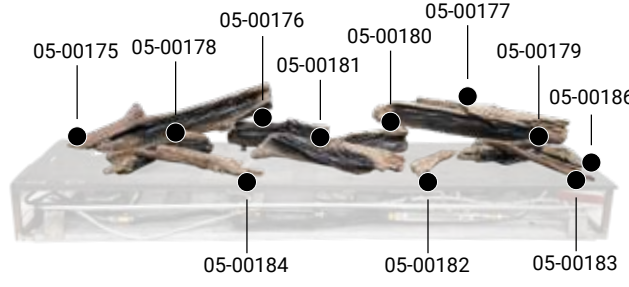
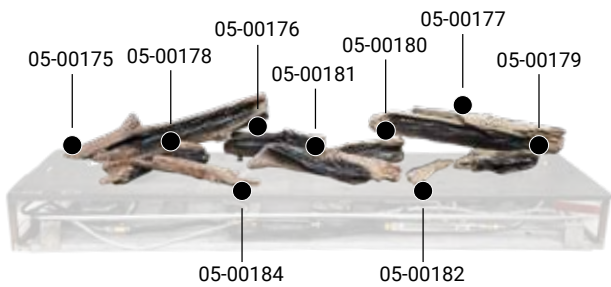
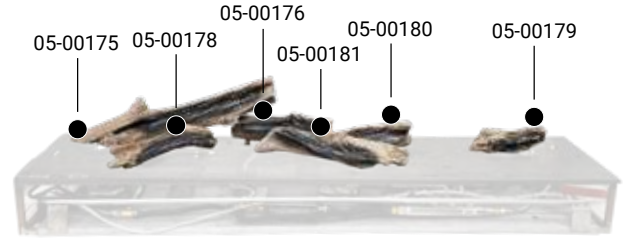
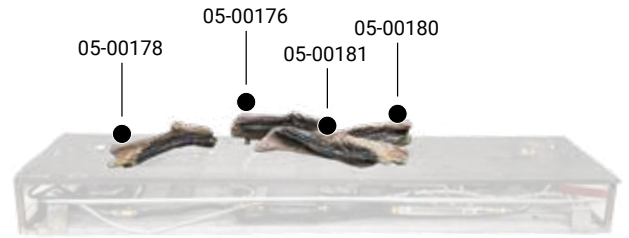
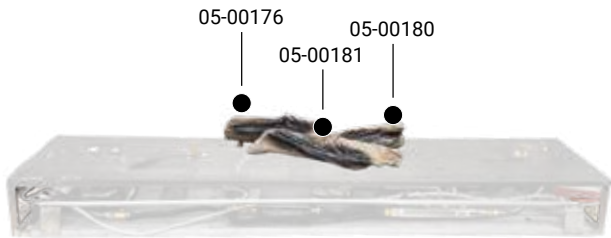
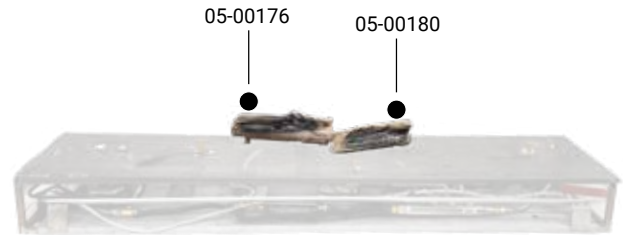
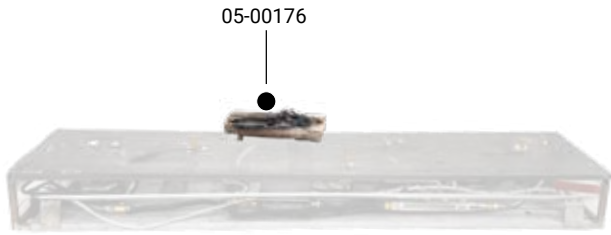



OUTDOOR INSTALLATION REQUIREMENTS

Bedrock Traditional from Grand Canyon Gas Logs have been tested and approved for installation outdoors under a patio cover and away from direct water contact or direct sun light. Grand Canyon Gas Logs standard warranty applies if installed per instructions. All electrical wiring shall be to local building codes. Consult professional installers before installation. Approved installations are as noted below.

Front Protection:

Patio roof overhang must be 50% (or more) of the height of the patio roof from bottom of fireplace.

If: $H=6'$

Then: $OD=3'$ minimum ($6' \times 50\%=3'$)

Note 1: Base of fireplace must be 2" (minimum) above floor.

Note 2: H taken from bottom of fireplace.

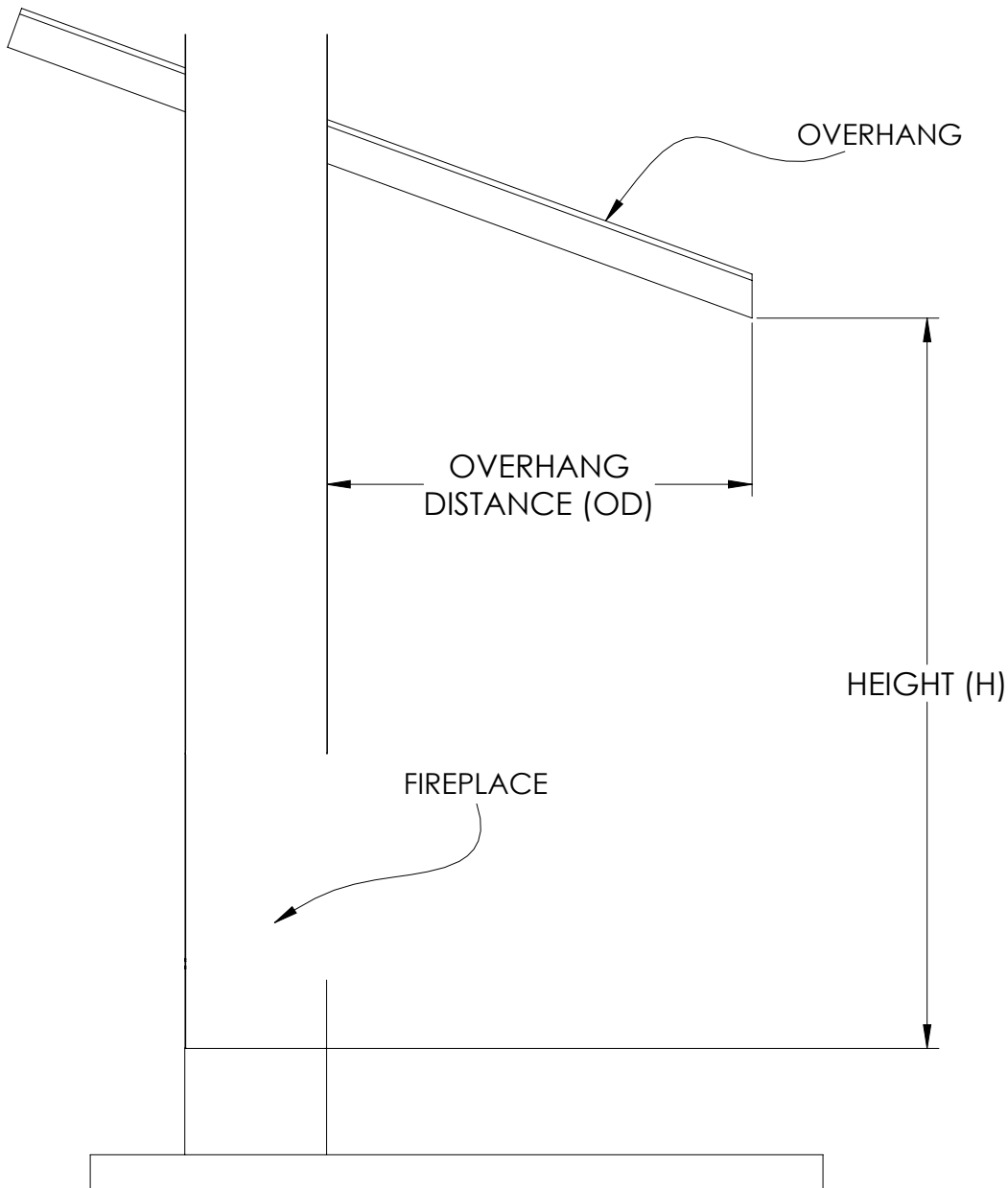

OUTDOOR INSTALLATION REQUIREMENTS

Side Protection:

Side distance (SD) must be 50% (or more) of the height (H).

If: $H=6'$

Then: $SD=3'$ minimum ($6' \times 50\%=3'$)

Note: H taken from bottom of fireplace.

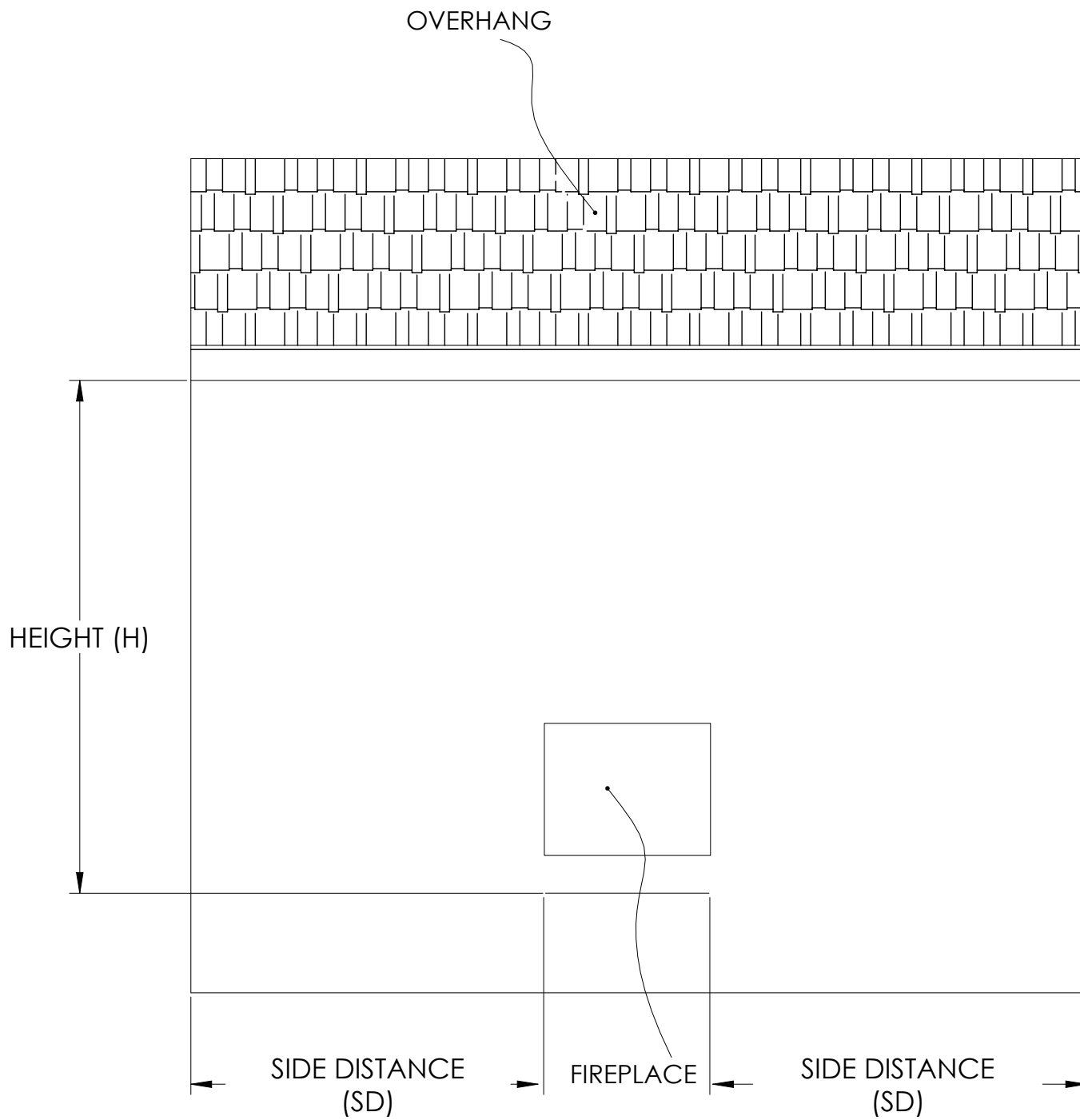

MULTIFUNCTION REMOTE OPERATING INSTRUCTIONS

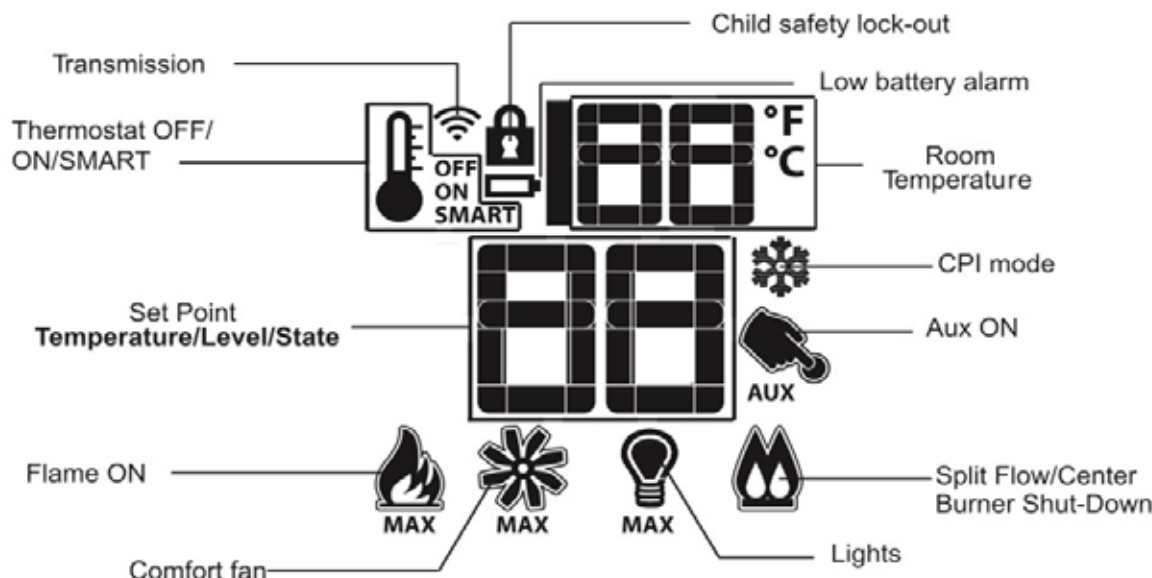

| TECHNICAL DATA | |
|-----------------------------|-----------------------------------|
| Remote Control | |
| Supply voltage | 4.5 V (three 1.5 V AAA batteries) |
| Ambient temperature ratings | 0-50°C (32 - 122°F) |
| Radio frequency | 315 MHz |

⚠ WARNING
The transmitter and receiver are radio frequency devices. Placing the receiver in or near metal may severely reduce the signal range.

⚠ WARNING
Turn off the main gas supply and electrical supply to the fireplace during installation and/or maintenance of the receiver device.

⚠ WARNING
FIRE HAZARD.
Can cause severe injury or death. The receiver causes ignition of the fireplace. The fireplace can turn on suddenly. Keep away from the fireplace burner when operating the remote system or activating manual bypass of the remote system.

⚠ CAUTION
PROPERTY DAMAGE HAZARD.
Excessive heat can cause property damage. The fireplace can stay lit for many hours. Turn off the fireplace if it is not going to be attended for any length of time. Always place the Transmitter where children can not reach it.

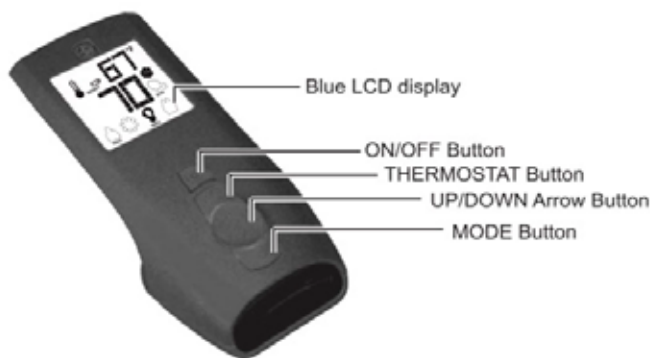

NOTICE: Not all features called out in the diagram above are available on this fireplace.

NOTICE: This control system includes a Battery Back-up pack that allows the Fireplace to operate in the event of a power outage.

NOTICE: The Accent Light and/or Blower features will not operate during a power outage.

NOTICE: Replace all Batteries at least once each year, preferably before at the beginning of the season.

⚠ CAUTION
FIRE OR EXPLOSION HAZARD.
Can cause property damage, severe injury or death. Do not attempt to take apart the gas control or to clean it. Improper assembly and cleaning can cause unreliable operation.

MULTIFUNCTION REMOTE OPERATING INSTRUCTIONS

Initializing the System for the First time (Re-Sync/Synchronize)

1. Remove the wall cover. Open the wall mounted battery back-up holder. **See Figure 7.1.** Install the four AA batteries into the wall mounted battery back-up holder then reinstall the cover. **See Figure 7.2.**
2. Install three AAA batteries into the battery bay located on the base of the transmitter. **See Figure 7.3.**
3. Set the wall remote slide switch to the REMOTE position. **See Figure 7.2.**
4. Press and release the SWI button on the wall control with a paper clip and the IFC module will beep three times to indicate the IFC module is ready to synchronize with the transmitter within ten seconds. **See Figure 7.2.**



Figure 7.1



Figure 7.2

5. With the batteries already installed in the Transmitter, push the ON button. The receiver will beep four times to indicate the transmitter's command is accepted and sets to the matching code of the transmitter. The system is now initialized.



Figure 7.3

Temperature Indication Display °C or °F

With the system in the OFF position, press the thermostat button and the mode button at the same time. Look at the LCD screen on the transmitter to verify that a °C or °F is visible to the right of the room temperature display. **See Figure 7.4 and 7.5.**



Figure 7.4



Figure 7.5

MULTIFUNCTION REMOTE OPERATING INSTRUCTIONS

Turn On the Fireplace

With the system OFF, press the ON/OFF Button on the Transmitter. The Transmitter display will show some other active icons on the screen. At the same time the Receiver will activate the fireplace. A single beep from the Receiver will confirm reception of the command.

Turn OFF the Fireplace

With the system ON, press the ON/OFF Button on the Transmitter. The Transmitter LCD display will only show the room temperature. See Figure 7.6. At the same time the Receiver will turn off the fireplace. A single beep from the Receiver confirms reception of the command.



Remote Control Display -

Remote Flame Control

The Proflame control has six flame levels. With the system on, and the flame level at maximum, each press the Down Arrow Button once will reduce the flame height by one step—until the flame is turned off.

The Up Arrow Button will increase the flame height each time it is pressed. If you press the Up Arrow Button while the system is on but the flame is off, the flame will come on in the high position.

See Figures 7.7 through 7.10. A single beep will confirm reception of the command.



Flame Off - Figure 7.7

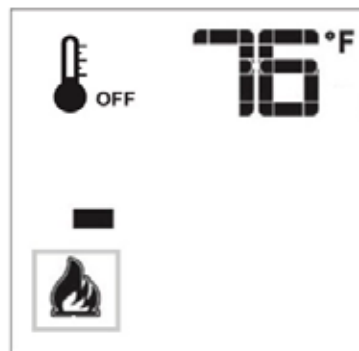

Flame Level 1 - Figure 7.8



Flame Level 5 - Figure 7.9



Flame Level Maximum - Figure 7.10

MULTIFUNCTION REMOTE OPERATING INSTRUCTIONS

During a prolonged power outage, the fireplace can operate in Continuous Pilot Mode. This reduces drain on the batteries used to ignite the burner and ensures the fireplace will continue to operate throughout the outage.

Continuous Pilot/Intermittent Pilot (CPI/IPI) Selection

With the system in OFF position press the Mode Button to index to the CPI mode icon. **Figure 7.11 and 7.12.** Pressing the Up Arrow Button will activate the CPI. Pressing the Down Arrow Button will return to IPI. A single beep will confirm the reception of the command.



Figure 7.11

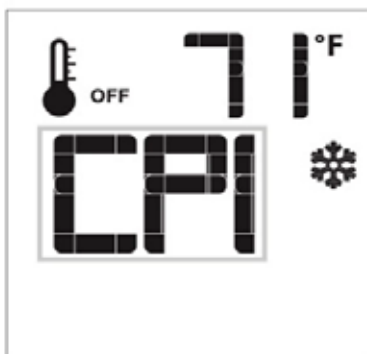

Figure 7.12

Button Lock

This function will lock the Buttons to prevent unsupervised operation.

To activate this function, press the MODE and UP Buttons at the same time. See **Figure 7.13.**

To deactivate this function, press the MODE and UP Buttons at the same time.

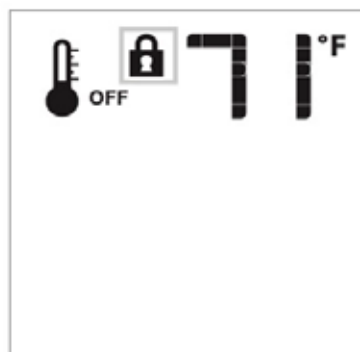

Figure 7.13

Low Battery Power Detection - Transmitter

The life span of the remote control batteries depends on various factors:

- Quality of the batteries
- How frequently the fireplace cycles on and off

When the transmitter batteries are low, an icon will appear on the LCD display of the transmitter. See **Figure 7.14** before all battery power is lost. When the batteries are replaced this icon will disappear.



Figure 7.14

Using the Fireplace without a Remote Control

The fireplace can be turned ON (HI only) and OFF with wall switch. The fireplace flame ON/OFF is the only function that will operate; no flame adjustment, light or blower will work when using the wall switch. The wall control switch should be turned OFF when the fireplace is not being used for extended periods of time.

Battery Backup Operation

Install batteries (See initialization sequence on page 123. In case of power loss, the fireplace will switch to battery mode automatically. The fireplace will operate normally without the fan or light control when in battery mode.

Low Battery Detection

When the backup batteries are low, the module emits a double-beep when it receives an on/off command. The system will not accept any commands until the batteries are replaced or A/C power is restored.

Lockout State Definition

To prevent damage to the fireplace, IFC board will automatically lockout the remote control if it detects a anomalous flame or too many unsuccessful ignition attempts. The lockout state will remain as long as the power supplies are applied.

When the IFC board goes into lockout state:

1. Both the Pilot and the Main Burner solenoids in the gas valve are de-energized;
2. A diagnostic code is sent through the diagnostic red LED.
3. The IFC board will ignore any burner ignition command and remain in the OFF state unless the unlock command sequence is met.

Turn the system power supplies (to the wall control or remote control) OFF for two or three seconds and then restore power. If the lockout reoccurs, call your dealer. The causes of lockout must be investigated under safe conditions by trained service personnel.

Wi-Fi APP MULTIFUNCTION REMOTE OPERATING INSTRUCTIONS

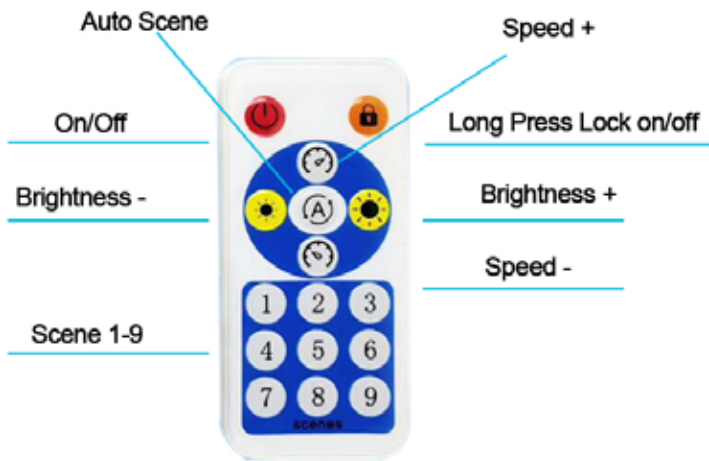

Download to your mobile device

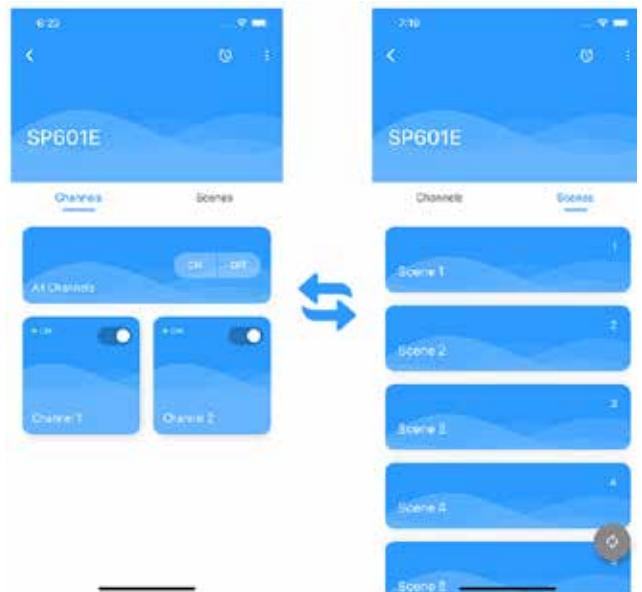

INTERMITTENT PILOT INSTRUCTIONS

FOR YOUR SAFETY READ BEFORE LIGHTING

⚠ WARNING

If you do not follow these instructions exactly, a fire or explosion may result causing property damage, personal injury or loss of life.

A. BEFORE LIGHTING smell all around the appliance area for gas. Be sure to smell next to the floor because some gas is heavier than air and will settle on the floor.

WHAT TO DO IF YOU SMELL GAS

- Do not try to light any appliance.
- Do not touch any electrical switch.
- Do not use any phone in your building.
- Immediately call your gas supplier from a neighbor's phone. Follow the gas supplier's instructions. • If you can not reach your gas supplier, call the fire department.

B. Use only your hand to push in or turn the gas control knob. Never use tools. If the knob will not push in or turn by hand, don't try to repair it, call a qualified service technician. Force or attempted repair may result in a fire or explosion.

C. Do not use this appliance if any part has been under water. Immediately call a qualified service technician to inspect the appliance and to replace any part of the control system and any gas control which has been under water.

LIGHTING INSTRUCTIONS

1. **STOP. Read the Safety information above this label.**
2. Read the Care and Operation manual on page 17.
3. Turn appliance's Gas shutoff Valve to the ON position.
4. If service was preformed, check that breaker was restored.
5. Wait five (5) minutes to clear air from fuel lines. Than smell for gas, including near the floor. If you smell gas, STOP! Follow "B" in the safety information above on this label. If you don't smell gas, go to next step.
6. Press ON/OFF with your Proflame II remote control Transmitter.
7. Listen for the Receiver's audio feedback. A single Beep will be heard.
8. The appliance will begin to light.
9. This device is equipped with an ignition device which automatically lights the pilot.
10. Do not try to light the pilot by hand.
11. If the appliance will not operate, follow the instructions "Shutdown instructions" and call your service technician or gas supplier.

Electronic Gas Control Valve - SIT Proflame

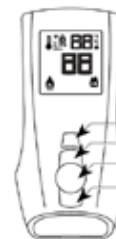

Remote Control Transmitter

ON/OFF Key
THERMOSTAT Key
UP/DOWN Arrow Key
MODE Key

Vent Free Pilot Assembly



Vented Pilot Assembly

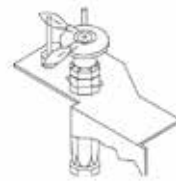

TO TURN OFF GAS TO FIREPLACE

1. Press On/off on your Proflame II remote control Transmitter
2. Listen for the Receivers audio feedback. A single beep will be heard.
3. Appliance will begin to turn off.
4. Extreme Temperatures caution. Do not attempt to touch any surface of the Bedrock system until adequate time for cooling is conducted.
5. Adequate time varies on, size of bedrock, duration of use, and outside temperatures.
6. Turn appliance's Gas shutoff valve to the Off position.
7. Turn of appliance's breaker, if service is to be performed.
8. **In case of an Emergency or access to Proflame II remote transmitter is lost.**
Bypass Proflame II remote control transmitter and move directly to gas shutoff valve. Turn valve to off position.

WARNING

- Turn off the gas and electrical power before servicing the appliance.
- Appliance may be hot. Do not service until appliance has cooled.
- Do not use abrasive cleaners on glass.
- Do not paint the pilot assembly.

This appliance and its venting system should be inspected before use and at least annually by a qualified service person. The following suggested checks should be performed by a qualified technician. The appliance area must be kept clear and free of combustible materials, gasoline, or other flammable vapors and liquids. The flow of combustion and ventilation air must not be obstructed.

NOTE:

Caution: Label all wires prior to disconnection when servicing controls. Wiring errors can cause improper and dangerous operation. Verify proper operation after servicing.

1. In order to properly clean the burner and pilot assembly, remove the glass to expose both assemblies.
2. Keep the control compartment, media, burner, air shutter opening, and the area surrounding the appliance clean by vacuuming or brushing, at least once a year.
3. Check to see that all burner ports are burning. Clean out any of the ports which may not be burning or are not burning properly.
4. Check to see that the pilot flame is large enough to engulf the flame sensor and/or thermocouple / thermopile as well as it reaches the burner.
5. If your appliance is equipped with a safety barrier, cleaning may be necessary due to excessive lint / dust from carpeting, pets, etc. Simply vacuum using the brush attachment.
6. If your appliance is equipped with relief doors, ensure the system performs effectively. Check that the gasket is not worn or damaged. Replace if necessary.
7. Replace the cleaned glass. Failure to properly position the media may cause carboning which can be distributed in the surrounding living area, inside the firebox and on exterior surfaces surrounding vent termination.
8. Check to see that the main burner ignites completely on all ports when turned on a 5 to 10 second total light-up period is satisfactory. If ignition takes longer, consult your local authorized dealer / distributor.
9. Visually inspect the appliance for carbon build up. Using a small whisk or brush, brush off the carbon and vacuum up or sweep into garbage.
10. **This step is not applicable for Vent Free appliances:** Check to see that the appliance is venting correctly. Ensure chimney system is safe and unobstructed. (If for any reason the vent air intake system is disassembled, re-install and re-seal per the instructions provided for the initial installation).
10. **Log care.** Ceramic logs are fragile. Handle with care. Chipping and flaking is normal and can be easily touched up.

| Symptom | Problem | Test Solution |
|--|--|---|
| Pilot will not light and / or makes noise with no spark at pilot burner. | Battery. | <ul style="list-style-type: none"> - Check batteries. |
| | Wiring. | <ul style="list-style-type: none"> - Verify the wire for the sensor and the wire for the igniter are connected to the correct terminals (not reversed) on the module. NOTE: Sensor has 3/16" (4.8mm) connection and igniter has 1/8" (3.2mm) connection. |
| | Loose connection. | <ul style="list-style-type: none"> - Verify no loose connections, electrical shorts in the wiring or ground out to any metal object. |
| | Module. | <ul style="list-style-type: none"> - Turn the ON/OFF switch to the "OFF" position. Remove the igniter wire from the module. Place the ON/OFF switch to the "ON" position. Hold a grounded wire about 3/16" (4.8mm) away from the igniter (spark) terminal on the module. If no spark the igniter terminal module must be replaced. If there is a spark the igniter terminal is fine. |
| | Igniter spark gap is incorrect. | <ul style="list-style-type: none"> - Spark gap of the igniter to the pilot should be 1/8" (3.2mm). |
| | Electrode. | <ul style="list-style-type: none"> - Inspect pilot assembly for a shorted wire or cracked insulator around the electrode. |
| | A shorted or loose - connection. | <ul style="list-style-type: none"> - Remove and reinstall the wiring harness that plugs into the module. Remove and verify continuity of each wire in wiring harness. |
| | Improper switch wiring. | <ul style="list-style-type: none"> - Troubleshoot the system with the simplest ON/OFF switch. |
| | Module is not grounded. | <ul style="list-style-type: none"> - Verify the valve and pilot assemblies are properly grounded to the metal chassis of the appliance. |
| Pilot sparks but will not light. | Gas supply. | <ul style="list-style-type: none"> - Verify that the incoming gas line ball valve is "Open". Verify that the inlet pressure reading is within acceptable limits, inlet pressures must not exceed 14" W.C.(34.9mb). |
| | Out of propane gas. | <ul style="list-style-type: none"> - Fill the tank. |
| Carbon is being deposited on glass, media or combustion chamber surfaces | Air shutter has become - blocked. | <ul style="list-style-type: none"> - Ensure air shutter opening is free of lint or other obstructions. |
| | Flame is impinging on the - glass, media, or combustion chamber. | <ul style="list-style-type: none"> - Check that the glass, logs, rocks or media are correctly positioned. - Open air shutter to increase the primary air. - Check the input rate: check the manifold pressure and orifice size as specified in the instructions. |

| Symptom | Problem | Test Solution |
|--|---|--|
| <p>Continues to spark and pilot lights, but main burner will not light.</p> | <p>Short or loose connection in sensor rod.</p> | <ul style="list-style-type: none"> – Verify all connections. Verify the connections from the pilot assembly are tight; also verify these connection are not grounding out to any metal. |
| | <p>Poor flame rectification or contaminated sensor rod.</p> | <ul style="list-style-type: none"> – Verify the flame is engulfing the sensor rod. This will increase the flame rectification. Verify correct pilot orifice is installed and inlet gas specifications to manual. (Remember, the flame carries the rectification current, not the gas. If the flame lifts from the pilot hood, the circuit is broken. A wrong orifice or too high of an inlet pressure can cause the pilot to lift). The sensor rod may need cleaning. |
| | <p>Poor grounding between pilot assembly and gas valve.</p> | <ul style="list-style-type: none"> – Verify that the wire harness is firmly connected to the module. Verify that the ceramic insulator around the sensor rod is not cracked, damaged, or loose. Verify the connection from the sensor rod to the sensor wire. |
| | <p>Damaged pilot or sensor rod.</p> | <ul style="list-style-type: none"> – Clean sensor rod with an emery cloth to remove any contamination that may have accumulated on the sensor rod. Verify continuity with multimeter with ohms set at the lowest range. Check for shorted wire or cracked insulator. |
| | <p>Pilot has been painted.</p> | <ul style="list-style-type: none"> – Using a piece of sandpaper or emery cloth, remove the paint from the pilot hood, igniter and flame sensor. |
| | <p>Wiring / connection.</p> | <ul style="list-style-type: none"> – Inspect all wires, ensure good tight connections. Verify that all wiring is installed exactly as specified. |
| | <p>Wiring harness.</p> | <ul style="list-style-type: none"> – Inspect the wiring harness, and verify the harness is tightly connected to the module. Verify that all wires are connected in the right order. See “wiring diagram” section. |
| <p>Pilot lights. Stops sparking / pilot remains lit but burner will not turn on.</p> | <p>Pilot has been painted.</p> | <ul style="list-style-type: none"> – Using a piece of sandpaper or emery cloth, remove the paint from the pilot hood, igniter and flame sensor. |
| <p>Exhaust fumes smells in room, headaches</p> | <p>Appliance is spilling.</p> | <ul style="list-style-type: none"> – Check that chimney is installed to building code. Room is in negative pressure; increase fresh air supply. Check damper positioning. Check for chimney blockage |

Burner:

Grand Canyon Gas Logs burners carry a life time warranty against manufacture defects or breakage as long as the appliance is installed inside and by a professional installer. In the event a defect or breakage occurs a replacement will be available for pick-up from the dealer at which the burner was originally purchased. This warranty is limited to original purchaser only. Indoor burners installed outside carry a (1) year warranty.

Electrical and Valves:

Grand Canyon Gas Logs valves, remotes, and receivers carry a (2) year warranty against breakage or defects from date of purchase, by original purchaser, and must be installed by a licensed professional installer. This warranty only covers use with Grand Canyon Gas Logs burners and logs. In the event a defect or breakage occurs a replacement will be available for pick-up from the dealer at which the burner was originally purchased. Batteries are not covered under this warranty. ODS pilot assemblies carry a (1) year warranty.

GlowFire™ Logs:

GlowFire™ Logs are manufactured with ceramic fiber and carry a lifetime warranty when installed indoors and a 2-year warranty when installed outdoors. The warranty covers any manufacture defects or breakage as long as the products are installed correctly. This warranty does not cover color fading due to use. In the event defect or breakage occurs, a replacement will be available to pick up from the dealer at which the log set was originally purchased or shipped directly to the customer if ordered online. This warranty does not cover breakage caused by excessive handling once installed and fired. This warranty is limited to original purchaser only.

WARRANTY CARD

Please fill this warrant card and mail it to Grand Canyon Gas Logs to receive a warranty claim

Purchased from (Showroom name) _____

City _____ State _____

Day/Month/Year _____

Model purchased _____

YOUR INFORMATION

Name: _____

City _____ State _____

Phone Number _____ Email _____

Date of install _____

Copy & Mail to:
Grand Canyon Gas Logs
3515 E. Atlanta Ave., Phoenix, AZ 85040

DO NOT RETURN TO STORE!



STOP CALL US FIRST

For immediate help with installation, product information or if your product arrives damaged, please call our toll free number at:

1-602-344-4217

(Monday - Friday, 8:00AM - 5:00PM, AZ Mountain Time)

or email us at:
customerservice@grandcanyongaslogs.com

OUR STAFF IS READY TO PROVIDE ASSISTANCE

Copyright 2023 All rights reserved U.S.A, and Foreign Patents Pending.