



ZC Fireplace Door

Overlap and Inside Fit



Installation & User Guide

Installer please leave this with homeowner

Thank You!

Thank you for purchasing a Stoll Fireplace Enclosure! We are confident this quality product will last you for years to come. If you need further help or additional information regarding installation, please reach out to your local dealer for assistance.

Parts and Tools

Parts and Tools		Qty
A.	Pressure Screw	8
B.	Allen Wrench	1
C.	Extension Tab	8
D.	1/2" Bolt	8



Installation

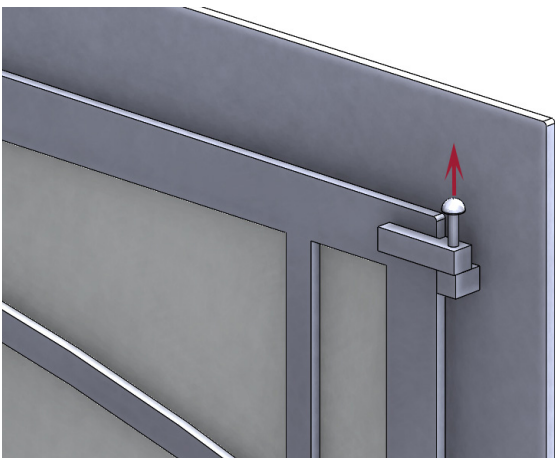

1. Remove the Glass Doors from the Main Frame. If the hinges have hinge pins, remove them first. Then lift up on the doors, lifting them off of their hinges.

2. Remove the Cabinet Mesh Screens from the enclosure (if applicable).

If Hanging Mesh Screens were ordered, follow the separate instructions to install them now. The hanging mesh panels are packed flat between layers of cardboard. Be careful not to discard them accidentally.

Need help? We also have a complete video installation guide!

(See back page for details.)

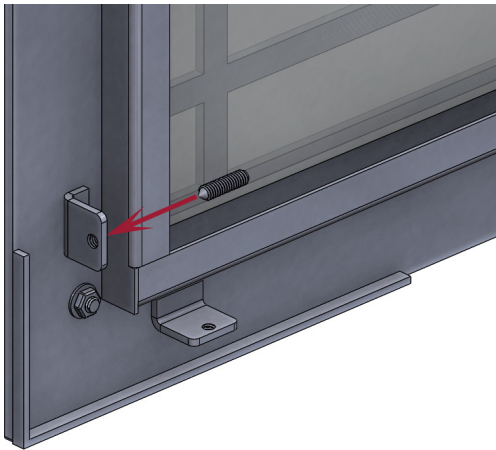

3. Insert the Pressure Screws (A) into the threaded holes on the pressure tabs.

4. Remove any protective plastic film from any polished metal or trim on the Fireplace Enclosure frame/doors (if applicable).

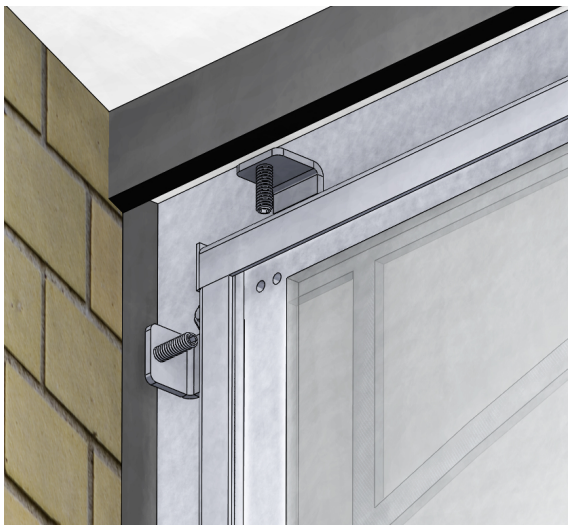

5. Center the Fireplace Enclosure frame in the fireplace opening.

6. Using the included Allen Wrench (B), tighten the Pressure Screws (A) against the fireplace opening, securing of the frame in place.

Tip: If needed, the Extension Tabs (C) can be secured to the existing pressure tabs with the 1/2" Screws (D), to extend deeper into the opening.

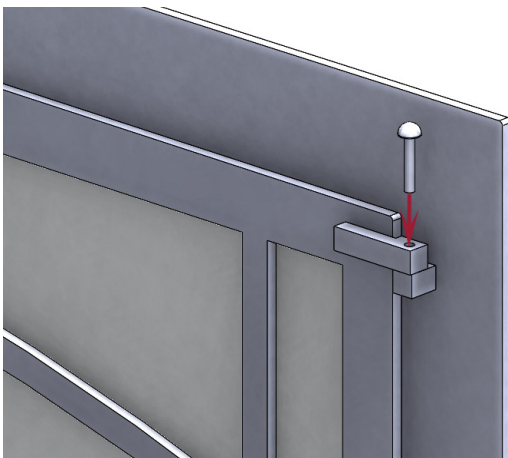

7. Re-install the Glass Doors. If your door has temporary plastic shipping hinge screws, discard them at this time and install the metal hinge pins that are taped to the glass doors (if applicable). *NOTE: Some door styles use hinges that do not use separate hinge pins.*

8. Re-install the Mesh Screen Doors (if applicable). A shipping spring is used on Mesh Screen Doors. The spring can be discarded or reinstalled to tighten the screen fit.

Operation & Maintenance

- Stoll Industries fireplace doors are designed to be used with glass doors open when the fire is burning. Exceptions to this rule may include Pyro-Ceramic glass, Airwash, and Outside Air Kits. Please discuss these options with your local Fireplace Dealer, as code requirements and applications can vary. *Stoll Industries does not accept any liability associated with burning with the doors closed on pre-manufactured fireboxes and ZC applications.*
- Excessive heat can cause damage to the Fireplace Enclosure and/or loss of temper in glass resulting in glass breakage. A very hot wood or gas fire, hot coals, embers, ashes, and/or logs coming in contact with the back of the enclosure can cause discoloration or more serious damage to the enclosure finishes. This type of damage, caused by overheating, is considered abuse and is not covered under warranty.
- If you are burning wood, and normally close the glass doors while the fire is dying down, keep in mind that this will tend to result in smoke residue or soot accumulation on the glass. If cleaned regularly this staining can be removed using glass cleaner or a mild household cleaner. For heavier stains, the use of a glass cleaner specifically formulated for removing wood smoke residue may be needed. Your local fireplace dealer can assist you in ordering this cleaner, if needed.
- Your Stoll door and door frame finish can be cleaned using a damp cloth, or mild household cleaner. To avoid damage to the finish, cleaners containing ammonia or other harsh chemicals should be avoided.

Disclaimer

In compliance with UL Code 127, our doors for ZC and pre-manufactured fireboxes come with air-gaps and spacers. These safety measures are in place to allow airflow in the event that the doors should accidentally close while burning, and to help ensure that the firebox does not overheat. By tampering with or closing off the air-flow in any way, the homeowner is accepting all liability and responsibility for any fire hazards that may occur.

Warranty

Your Fireplace Doors are covered by a 5 year limited warranty. For more information, please visit www.stollindustries.com/resources/. All warranty claims must be placed through your local dealer.



To watch our video installation guide, please scan the barcode, or visit the link below:

www.stollindustries.com/video-library/

WARNING

This product can expose you to chemicals including Carbon Black, which is known to the state of California to cause Cancer. For more information go to www.P65Warnings.ca.gov